

# Class CC Fuses

## KLDR Series

600 V ac • 300 V dc • Time-Delay •  $\frac{1}{10}$ –30 A



### Description

KLDR time-delay fuses are designed to protect control transformers, solenoids and similar inductive components with high magnetizing currents during the first half-cycle. They provide excellent protection of motor branch circuits containing IEC or NEMA rated motor controllers or contactors.

### Features & Benefits

FEATURES	BENEFITS
<b>Excellent short-circuit protection</b>	Improve safety through faster response to fault currents
<b>Current limiting</b>	Restricts fault currents to provide high degree of circuit protection
<b>Rejection feature</b>	Prevents use of fuses with lower interrupting ratings or voltage when used with corresponding fuse holders

### Applications

- Transformer Protection

### Specifications

<b>Voltage Rating</b>	Ac: 600 V Dc: 300 V
<b>Amperage Rating</b>	$\frac{1}{10}$ –30 A
<b>Interrupting Rating</b>	Ac: 200,000 A rms symmetrical Dc: 20,000 A
<b>Material</b>	Body: Melamine Caps: Nickel-plated Bronze
<b>Fuse Weight</b>	.019 lb (8.62g)
<b>Approvals</b>	Ac: Standard 248-4, Class CC Dc: Littelfuse self-certified
<b>Environmental</b>	RoHS Compliant
<b>Country of Origin</b>	Mexico

# Class CC Fuses

## KLDR Series

### Certification & Compliance

<b>UL</b>	UL Listed (File: E81895)
<b>CSA</b>	CSA Certified (File: LR29862)
<b>CE</b>	EU_DOC-KLDR_P_210128

### Accessories

**L60030C series** fuse holder

**LPSC Touch-Safe series** fuse holder

**LEC series** inline fuse holder

**571/572 series** panel mount fuse holder

### Ordering Information

AMPERE RATING	CATALOG NUMBER	PRODUCT MARKING	PACKING QUANTITY	ORDERING NUMBER	UPC CODE
1/10	KLDR.100	KLDR 1/10A	10	KLDR.100TXP	07945896877
			100	KLDR.100HXP	07945879278
1/8	KLDR.125	KLDR 1/8A	10	KLDR.125TXP	07945896878
			100	KLDR.125HXP	07945879279
15/100	KLDR.150	KLDR 15/100A	10	KLDR.150TXP	07945896879
			100	KLDR.150HXP	07945879280
3/16	KLDR.187	KLDR 3/16A	10	KLDR.187TXP	07945896880
			100	KLDR.187HXP	07945879281
3/10	KLDR.200	KLDR 3/10A	10	KLDR.200TXP	07945879239
			100	KLDR.200HXP	07945879282
1/4	KLDR.250	KLDR 1/4A	10	KLDR.250TXP	07945879240
			100	KLDR.250HXP	07945879283
3/10	KLDR.300	KLDR 3/10A	10	KLDR.300TXP	07945879241
			100	KLDR.300HXP	07945879284
3/10	KLDR.400	KLDR 3/10A	10	KLDR.400TXP	07945879242
			100	KLDR.400HXP	07945879285
1/2	KLDR.500	KLDR 1/2A	10	KLDR.500TXP	07945879243
			100	KLDR.500HXP	07945879286
3/10	KLDR.600	KLDR 3/10A	10	KLDR.600TXP	07945879244
			100	KLDR.600HXP	07945879287
3/4	KLDR.750	KLDR 3/4A	10	KLDR.750TXP	07945879245
			100	KLDR.750HXP	07945879288
3/10	KLDR.800	KLDR 3/10A	10	KLDR.800TXP	07945879246
			100	KLDR.800HXP	07945879289
1	KLDR001	KLDR 1A	10	KLDR001.TXP	07945879247
			100	KLDR001.HXP	07945879290
1 1/8	KLDR1.12	KLDR 1-1/8A	10	KLDR1.12TXP	07945879248
			100	KLDR1.12HXP	07945879291
1 1/4	KLDR1.25	KLDR 1-1/4A	10	KLDR1.25TXP	07945879249
			100	KLDR1.25HXP	07945879292
1 3/10	KLDR01.4	KLDR 1-3/10A	10	KLDR01.4TXP	07945879250
			100	KLDR01.4HXP	07945879293
1 1/2	KLDR01.5	KLDR 1-1/2A	10	KLDR01.5TXP	07945879251
			100	KLDR01.5HXP	07945879294
1 5/10	KLDR01.6	KLDR 1-5/10A	10	KLDR01.6TXP	07945879252
			100	KLDR01.6HXP	07945879295

# Class CC Fuses

## KLDR Series

### Ordering Information (cont.)

AMPERE RATING	CATALOG NUMBER	PRODUCT MARKING	PACKING QUANTITY	ORDERING NUMBER	UPC CODE
1 $\frac{1}{10}$	KLDR01.8	KLDR 1- $\frac{1}{10}$ A	10 100	KLDR01.8TXP KLDR01.8HXP	07945879253 07945879296
2	KLDR002	KLDR 2A	10 100	KLDR002.TXP KLDR002.HXP	07945879254 07945879297
2 $\frac{1}{4}$	KLDR2.25	KLDR 2- $\frac{1}{4}$ A	10 100	KLDR2.25TXP KLDR2.25HXP	07945879255 07945879298
2 $\frac{1}{2}$	KLDR02.5	KLDR 2- $\frac{1}{2}$ A	10 100	KLDR02.5TXP KLDR02.5HXP	07945879256 07945879299
2 $\frac{3}{10}$	KLDR02.8	KLDR 2- $\frac{3}{10}$ A	10 100	KLDR02.8TXP KLDR02.8HXP	07945879257 07945879300
3	KLDR003	KLDR 3A	10 100	KLDR003.TXP KLDR003.HXP	07945879258 07945879301
3 $\frac{1}{10}$	KLDR03.2	KLDR 3- $\frac{1}{10}$ A	10 100	KLDR03.2TXP KLDR03.2HXP	07945879259 07945879302
3 $\frac{1}{2}$	KLDR03.5	KLDR 3- $\frac{1}{2}$ A	10 100	KLDR03.5TXP KLDR03.5HXP	07945879260 07945879303
4	KLDR004	KLDR 4A	10 100	KLDR004.TXP KLDR004.HXP	07945879261 07945879304
4 $\frac{1}{2}$	KLDR04.5	KLDR 4- $\frac{1}{2}$ A	10 100	KLDR04.5TXP KLDR04.5HXP	07945879262 07945879305
5	KLDR005	KLDR 5A	10 100	KLDR005.TXP KLDR005.HXP	07945879263 07945879306
5 $\frac{1}{10}$	KLDR05.6	KLDR 5- $\frac{1}{10}$ A	10 100	KLDR05.6TXP KLDR05.6HXP	07945879264 07945879307
6	KLDR006	KLDR 6A	10 100	KLDR006.TXP KLDR006.HXP	07945879265 07945879308
6 $\frac{1}{4}$	KLDR6.25	KLDR 6- $\frac{1}{4}$ A	10 100	KLDR6.25TXP KLDR6.25HXP	07945879266 07945879309
7	KLDR007	KLDR 7A	10 100	KLDR007.TXP KLDR007.HXP	07945879267 07945879310
7 $\frac{1}{2}$	KLDR07.5	KLDR 7- $\frac{1}{2}$ A	10 100	KLDR07.5TXP KLDR07.5HXP	07945879268 07945879311
8	KLDR008	KLDR 8A	10 100	KLDR008.TXP KLDR008.HXP	07945879269 07945879312
9	KLDR009	KLDR 9A	10 100	KLDR009.TXP KLDR009.HXP	07945879270 07945879313
10	KLDR010	KLDR 10A	10 100	KLDR010.TXP KLDR010.HXP	07945879271 07945879314
12	KLDR012	KLDR 12A	10 100	KLDR012.TXP KLDR012.HXP	07945879272 07945879315
15	KLDR015	KLDR 15A	10 100	KLDR015.TXP KLDR015.HXP	07945879273 07945879316
17 $\frac{1}{2}$	KLDR17.5	KLDR 17- $\frac{1}{2}$ A	10 100	KLDR17.5TXP KLDR17.5HXP	07945879274 07945879317
20	KLDR020	KLDR 20A	10 100	KLDR020.TXP KLDR020.HXP	07945879275 07945879318
25	KLDR025	KLDR 25A	10 100	KLDR025.TXP KLDR025.HXP	07945879276 07945879319
30	KLDR030	KLDR 30A	10 100	KLDR030.TXP KLDR030.HXP	07945879277 07945879320

# Class CC Fuses KLDR Series

## Dimensions

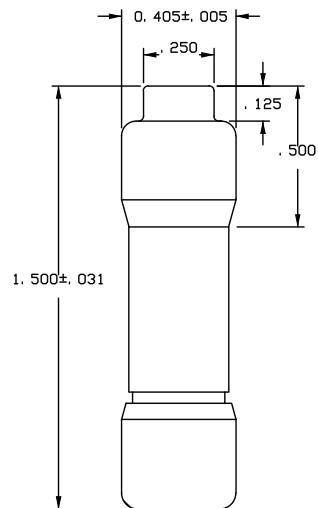

## Electrical Specification - Agency Requirements

AMPERAGE RATING	OPENING TIME		
	100 % OF AMP RATING PER UL	135 % OF AMP RATING PER UL	200 % OF AMP RATING PER UL
$\frac{1}{10}$ -30	Temperature Stabilization	60 Minutes Max	12 Seconds Minimum

## Electrical Specifications

CATALOG NUMBER	VOLTAGE RATING (V)		INTERRUPTING RATING (A)		MELT (PRE-ARC) I <sup>2</sup> T (A <sup>2</sup> S)	TOTAL CLEARING I <sup>2</sup> T (A <sup>2</sup> S)	AGENCY APPROVALS	
	AC	DC	AC	DC			UL	CSA
KLDR.100	600	300	200,000	20,000	.0004	.0059	•	•
KLDR.125	600	300	200,000	20,000	.0007	.0055	•	•
KLDR.150	600	300	200,000	20,000	.0016	.0059	•	•
KLDR.187	600	300	200,000	20,000	.0040	.0267	•	•
KLDR.200	600	300	200,000	20,000	.0018	.0230	•	•
KLDR.250	600	300	200,000	20,000	.0138	.0967	•	•
KLDR.300	600	300	200,000	20,000	.0111	.1005	•	•
KLDR.400	600	300	200,000	20,000	.0579	.1420	•	•
KLDR.500	600	300	200,000	20,000	.0877	.3121	•	•
KLDR.600	600	300	200,000	20,000	.1404	.3742	•	•
KLDR.750	600	300	200,000	20,000	.2911	1.972	•	•
KLDR.800	600	300	200,000	20,000	.2416	2.064	•	•
KLDR001	600	300	200,000	20,000	.4494	5.883	•	•
KLDR1.12	600	300	200,000	20,000	.5049	5.149	•	•
KLDR1.25	600	300	200,000	20,000	.4367	7.354	•	•
KLDR01.4	600	300	200,000	20,000	.8135	7.639	•	•
KLDR01.5	600	300	200,000	20,000	.9302	5.885	•	•
KLDR01.6	600	300	200,000	20,000	.7495	6.682	•	•

# Class CC Fuses

## KLDR Series

### Electrical Specifications (cont.)

CATALOG NUMBER	VOLTAGE RATING (V)		INTERRUPTING RATING (A)		MELT (PRE-ARC) I <sup>2</sup> T (A <sup>2</sup> S)	TOTAL CLEARING I <sup>2</sup> T (A <sup>2</sup> S)	AGENCY APPROVALS	
	AC	DC	AC	DC			UL	CSA
KLDR01.8	600	300	200,000	20,000	.9964	6.594	•	•
KLDR002	600	300	200,000	20,000	.8615	14.01	•	•
KLDR2.25	600	300	200,000	20,000	1.126	26.41	•	•
KLDR02.5	600	300	200,000	20,000	2.087	35.35	•	•
KLDR02.8	600	300	200,000	20,000	21.28	45.47	•	•
KLDR003	600	300	200,000	20,000	23.21	55.99	•	•
KLDR03.2	600	300	200,000	20,000	37.92	57.27	•	•
KLDR03.5	600	300	200,000	20,000	21.42	109.4	•	•
KLDR004	600	300	200,000	20,000	83.81	258.6	•	•
KLDR04.5	600	300	200,000	20,000	83.89	110.6	•	•
KLDR005	600	300	200,000	20,000	63.33	84.04	•	•
KLDR05.6	600	300	200,000	20,000	87.66	114.0	•	•
KLDR006	600	300	200,000	20,000	129.5	161.9	•	•
KLDR6.25	600	300	200,000	20,000	147.6	261.7	•	•
KLDR007.	600	300	200,000	20,000	202.4	513.4	•	•
KLDR07.5	600	300	200,000	20,000	321.8	813.0	•	•
KLDR008	600	300	200,000	20,000	111.2	1,145	•	•
KLDR009	600	300	200,000	20,000	73.40	1,334	•	•
KLDR010	600	300	200,000	20,000	132.0	934.8	•	•
KLDR012	600	300	200,000	20,000	154.7	1,723	•	•
KLDR015	600	300	200,000	20,000	200.5	2,248	•	•
KLDR17.5	600	300	200,000	20,000	87.50	722.8	•	•
KLDR020	600	300	200,000	20,000	123.8	1,363	•	•
KLDR025	600	300	200,000	20,000	226.0	1,710	•	•
KLDR030	600	300	200,000	20,000	299.6	1,990	•	•

# Class CC Fuses

## KLDR Series

### Current-Limiting Effects

SHORT CIRCUIT CURRENT*	APPARENT RMS SYMMETRICAL CURRENT FOR VARIOUS FUSE RATINGS								
	4 A	6 A	7.5 A	8 A	10 A	12 A	15 A	20 A	30 A
5,000	349	420	521	437	359	369	435	456	621
10,000	440	529	656	551	452	465	548	575	783
15,000	504	605	751	631	517	532	627	658	896
20,000	554	666	827	694	569	585	690	724	986
25,000	597	718	890	748	613	630	743	780	1063
30,000	634	763	946	795	651	670	790	829	1129
35,000	668	803	996	837	686	705	832	872	1189
40,000	698	840	1041	875	717	737	870	912	1243
50,000	752	904	1122	942	772	794	937	983	1339
60,000	799	961	1192	1001	821	844	995	1044	1423
80,000	880	1058	1312	1102	903	929	1096	1149	1566
100,000	948	1139	1413	1187	973	1001	1180	1238	1687
150,000	1085	1304	1618	1359	1114	1146	1351	1417	1931
200,000	1194	1436	1781	1496	1226	1261	1487	1560	2125

\*Prospective RMS Symmetrical Amperes Short-Circuit Current  
 Note: Data Derived from Peak Let-Thru Curves

### Temperature Derating Curve (Temperature of Air Immediately Surrounding Fuse)

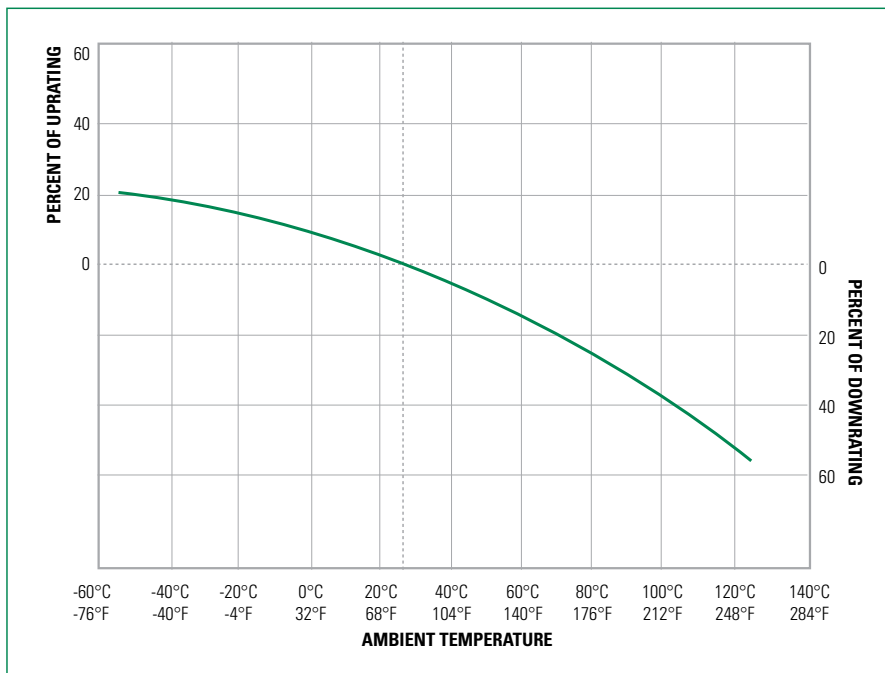

# Class CC Fuses KLD R Series

## Peak Let-Thru Curves

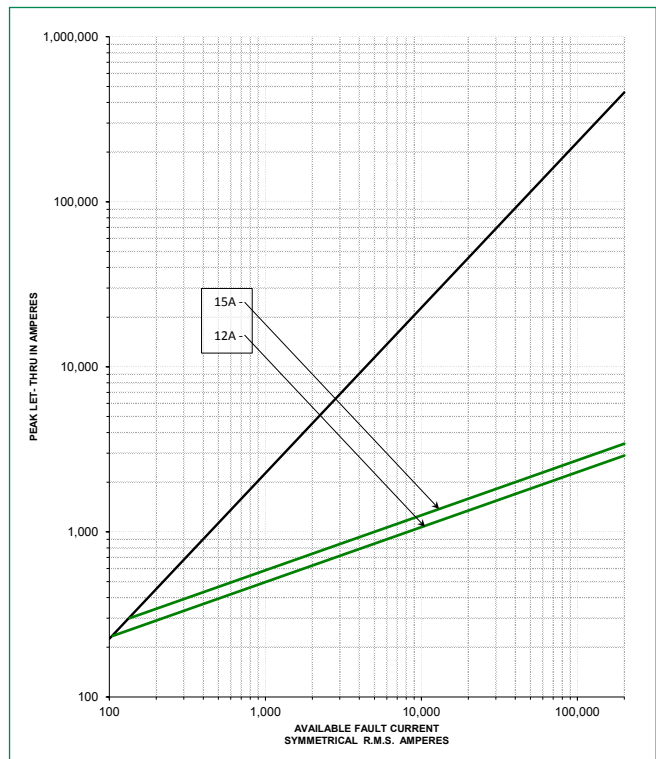
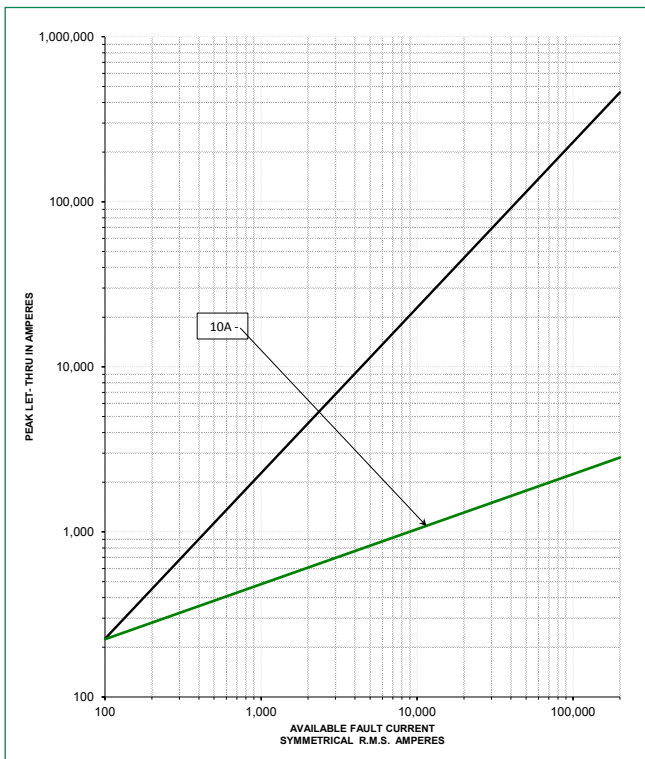
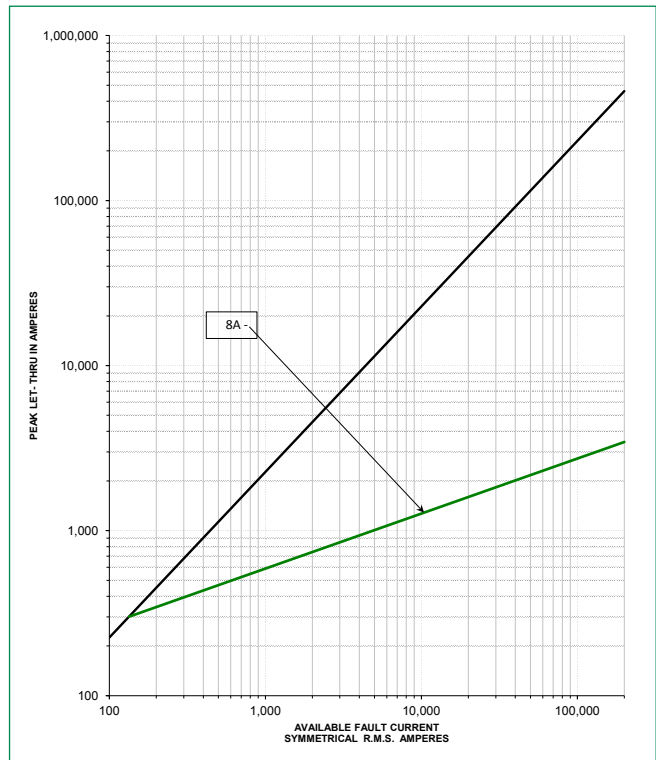
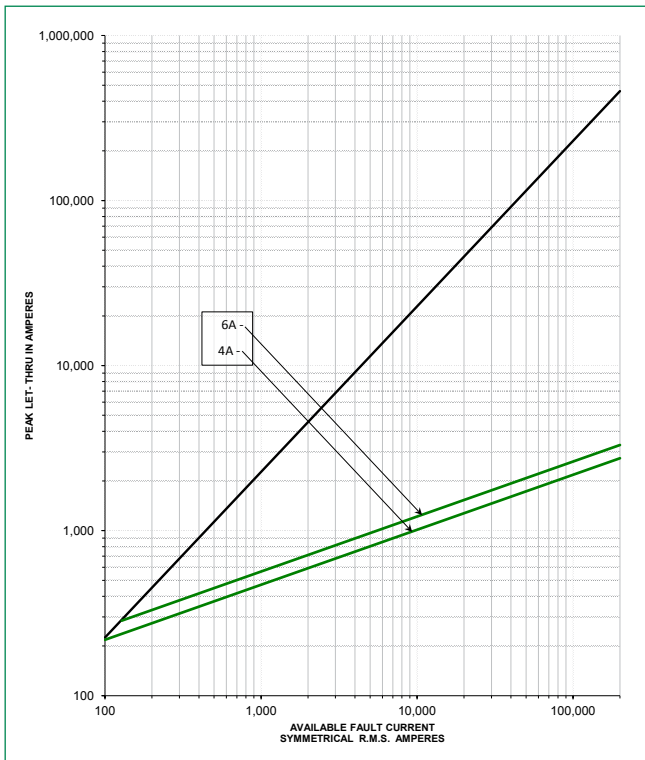

# Class CC Fuses

## KLDR Series

### Peak Let-Thru Curves (cont.)

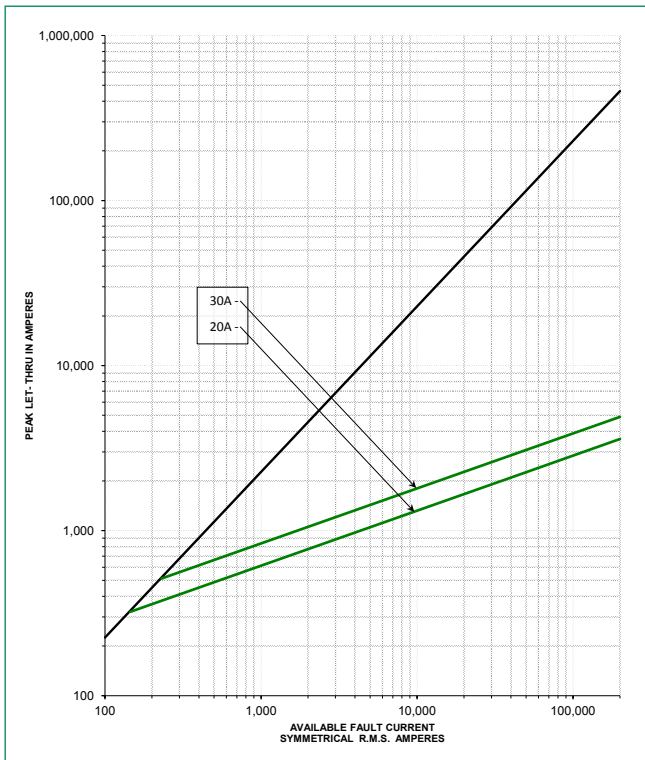

### Time Current Curves

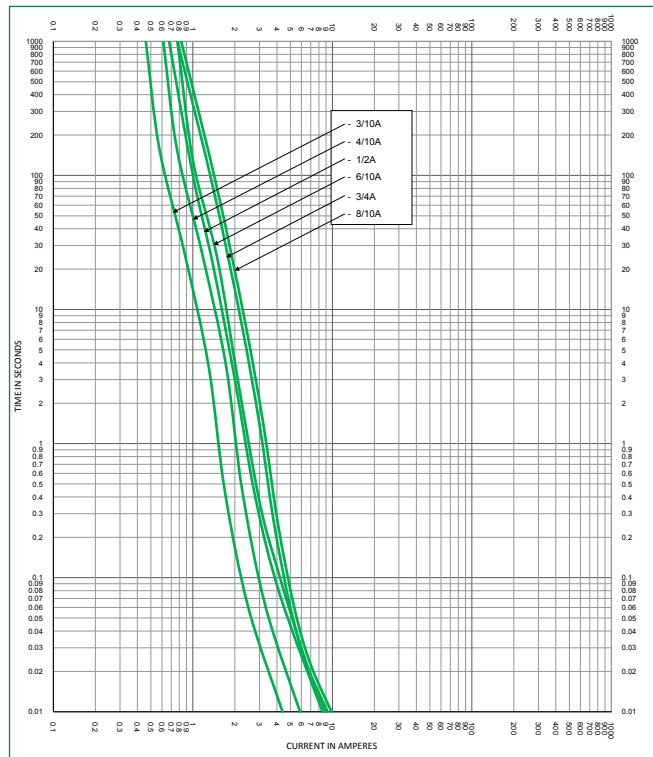
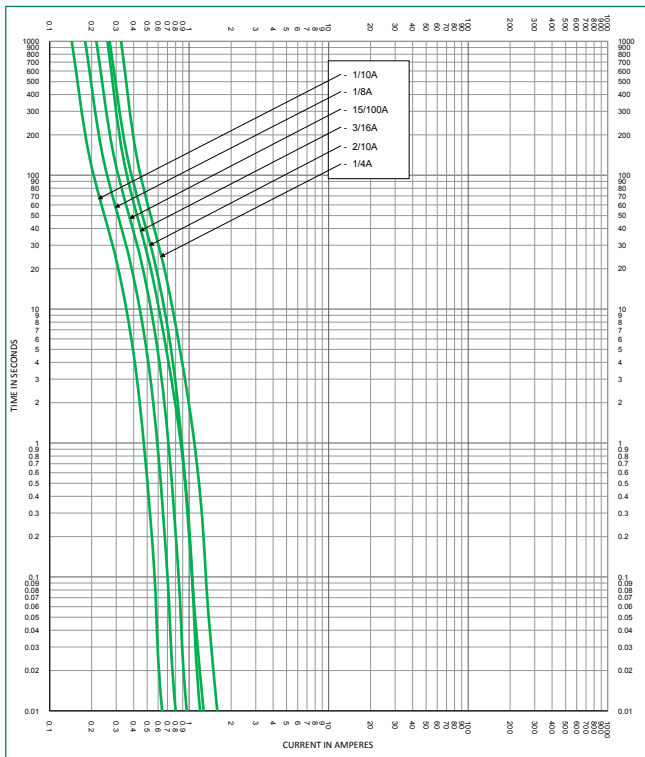



# Class CC Fuses

## KLDR Series

### Time Current Curves (cont.)

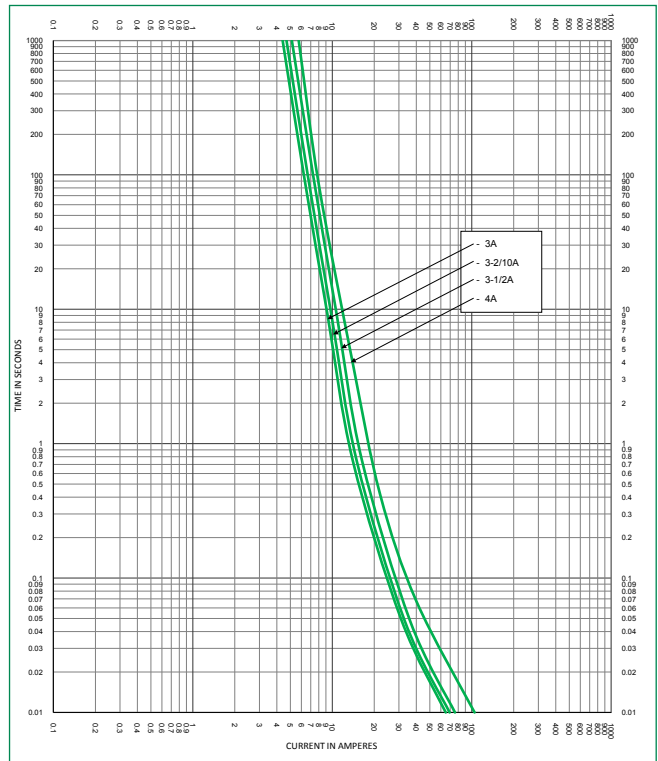
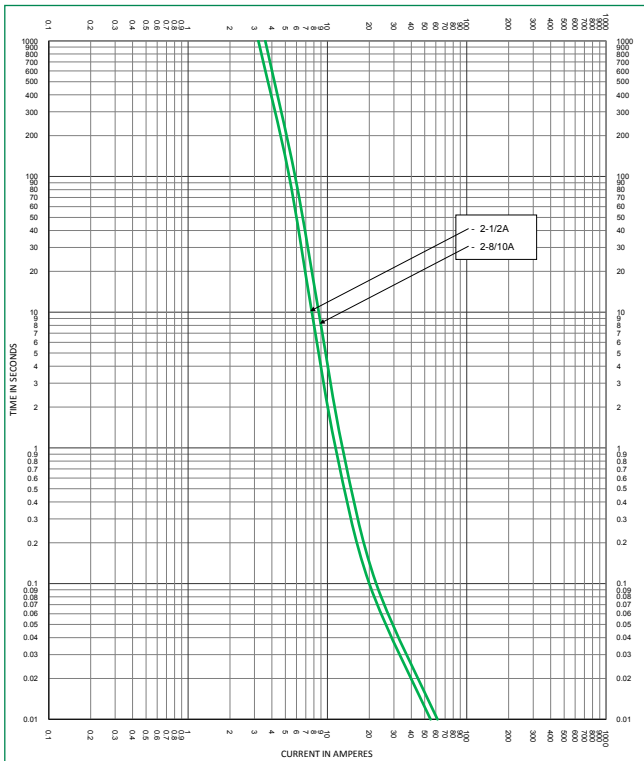
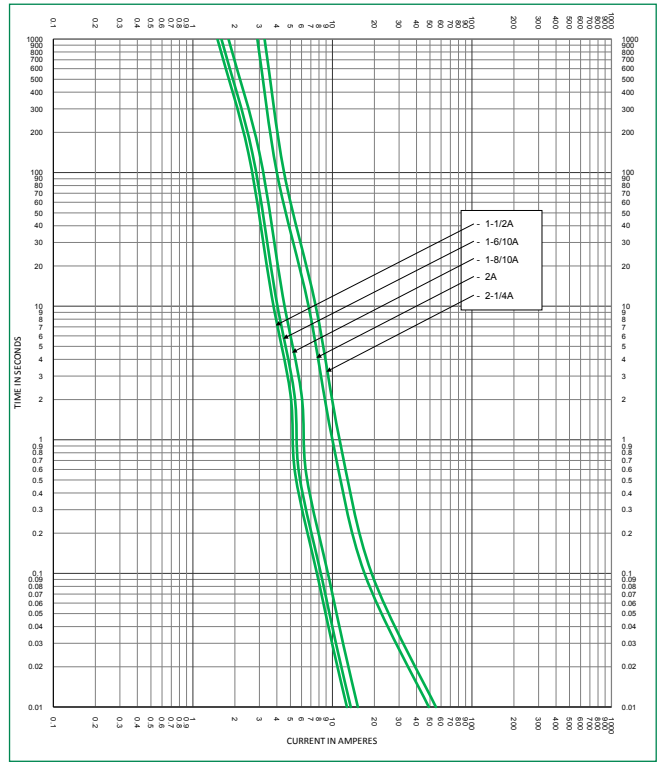
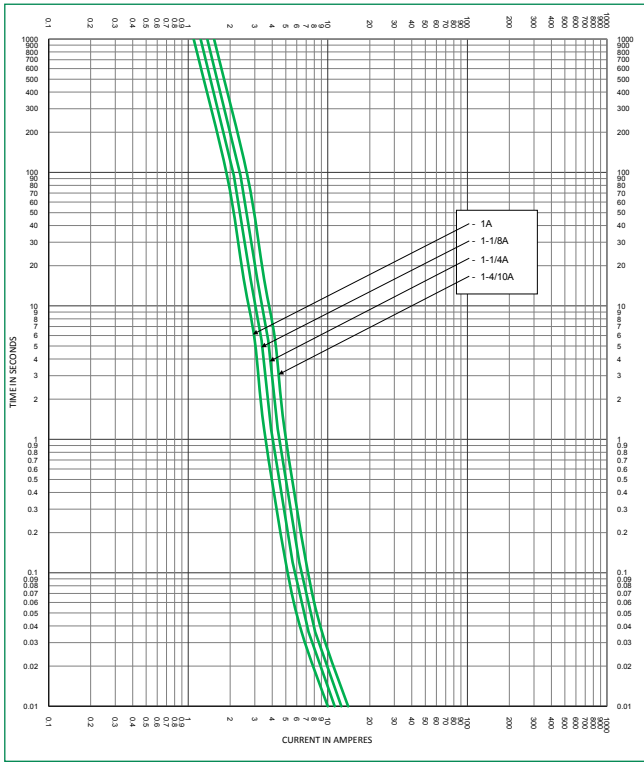

# Class CC Fuses KLDR Series

## Time Current Curves (cont.)

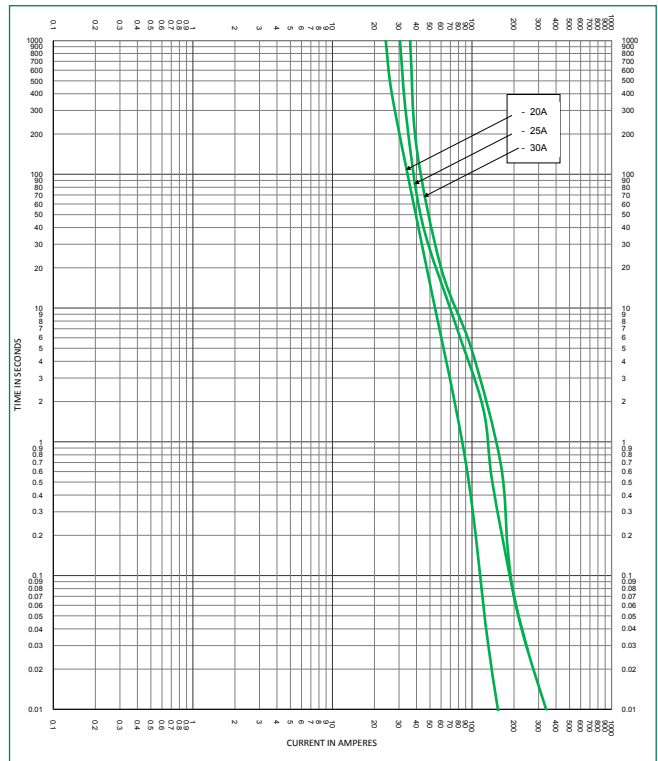
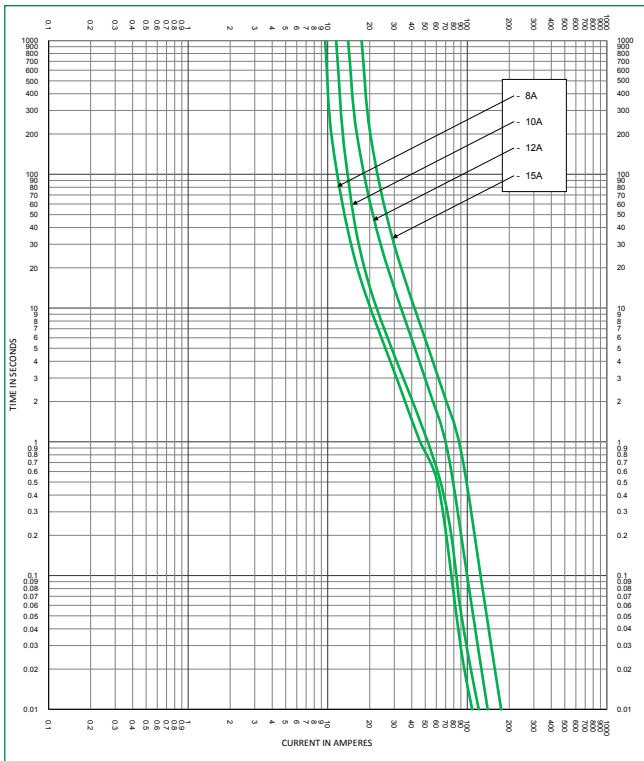
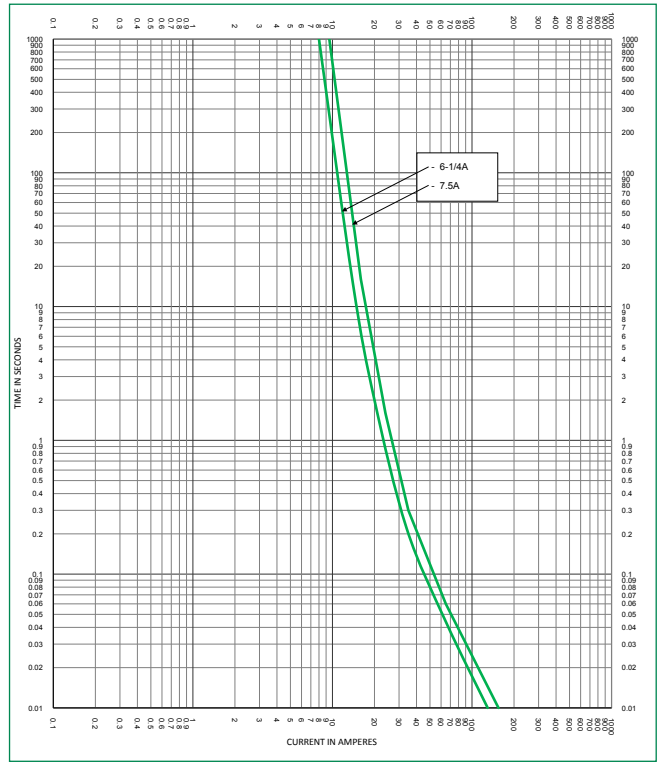
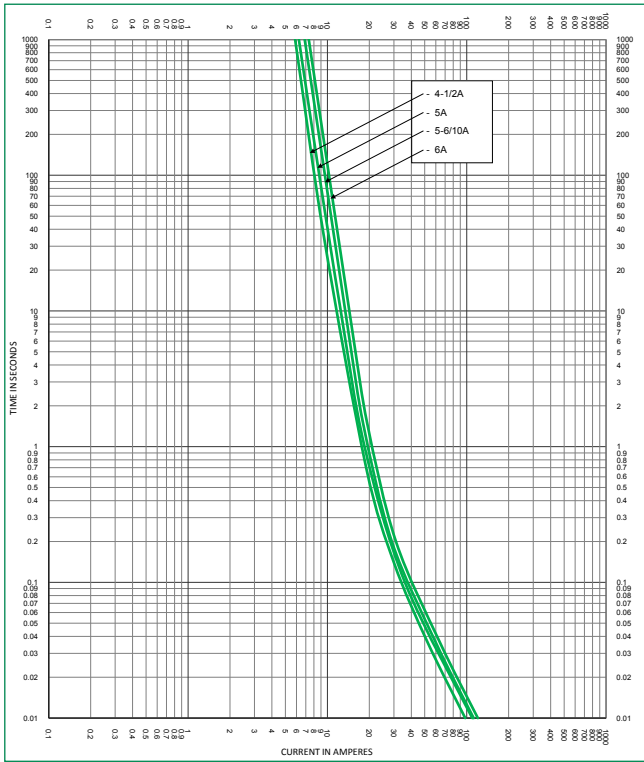

**Disclaimer Notice** – Information furnished is believed to be accurate and reliable. However, users should independently evaluate the suitability of and test each product selected for their own applications. Littelfuse products are not designed for, and may not be used in, all applications. Read complete Disclaimer Notice at [www.littelfuse.com/product-disclaimer](http://www.littelfuse.com/product-disclaimer).